

TOX®-Process Monitoring CEP 400T

Data sheet 100.20
2020/02



TOX[®]-Process Monitoring CEP 400T

The TOX[®]-Process monitoring monitors clinching and joining processes and provides important data about the process sequence.

Functions:

- Real names for program memory, up to 40 characters
- 64 sensor configurations per channel
- 4 password levels: operator, setup technician, integrator, manufacturer
- 16 digital inputs and 8 digital outputs
- Status indicator menu of digital I/O ports
- Stores up to 1000 values with time stamp
- Includes TOX[®]softWare for parameterization and data recording
- Choice of panel mount unit or wall mount unit IP54
- Ethernet interface
- Provides important information about the process sequence
- Special monitoring by means of window technology for clinching processes
- Individual measuring programs available
- Storage of final values
- Several password levels
- Color touchscreen
- Versions with 1/2/4/8/12 channels
- Individual evaluation with 1-/2 channel versions

Optional expansion:

- Field bus interfaces of all common bus systems*
- Process sequence control for TOX[®]-Clinching Processes
- Service modules such as
 - Remote maintenance
 - Test control unit to check measuring chain
- Analog output 0–10V
- Evaluation unit for bench top presses TOX[®]-FinePress
- Display of control dimension X (absolute value)

*With field bus connection, individual evaluation IO/NIO and end values are displayed, independent of the number of measuring channels in the device.



Technical data	CEP 400T
Application	Monitoring of force processes
Supply voltage	24VDC
Current consumption	≤ 1 A
Display	5.7" color touchscreen TFT LCD 640x480 (VGA) Color depth 16 bit
Inputs / Outputs	Digital: 16 inputs / 8 outputs
Number of measuring programs	64
Dimensions WxHxD (mm)	Built-in unit: 210x185x123.5 (D 99 for two slots) Wall mounted unit: 400x360x160
Weight	Built-in unit: 1.5kg Wall mounted unit: 4kg
Interfaces	Ethernet, USB, Digital In/Out
Fieldbus interfaces	PROFIBUS DP, PROFINET CU, DeviceNet, Ethernet IP, CANopen, PROFINET LWL, EtherCAT separate gateway for 12 channel devices
Protection class	Built-in unit IP54 front panel IP20 housing Wall mounted unit IP54
Number of measuring channels	1/2/4/8/12
Measuring channels: Force DMS Force standard signal	■ ■
Measuring channel resolution	12/16 Bit
Max. measuring interval	2000Hz
Monitoring by means of window technology	■
Password protection	■
Number of last final values in memory	1000
Data backup	1000 final values transferrable to USB memory stick as CSV file Data backup with TOX®softWare

TOX[®]-Process Monitoring CEP 400T

Connections

Wall mounted unit

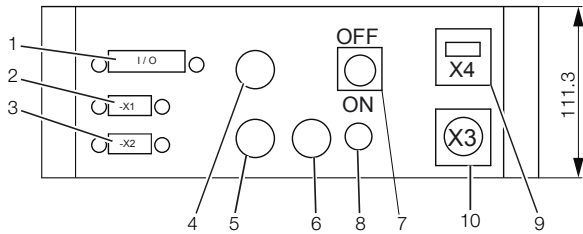

- 1 Input/Output digital
- 2 Fieldbus interface (option)
- 3 Reserve
- 4 XK 1-4 Force transducer
- 5 XK 5-8 Force transducer
- 6 XK 9-12 Force transducer
- 7 Main switch
- 8 Supply voltage 24VDC
- 9 USB interface
- 10 Ethernet interface

Build-in unit

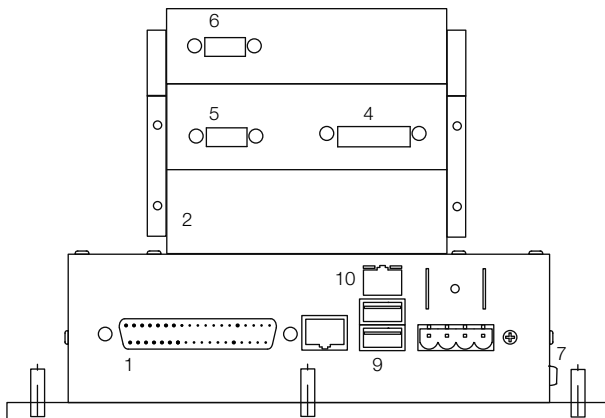

TOX®-Process Monitoring CEP 400T

Dimensions

Wall mounted unit

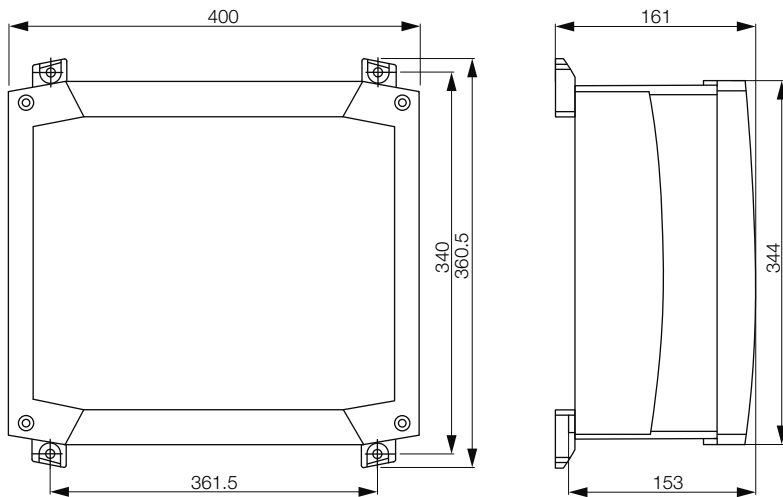

Built-in unit

